

2020

PAS Patterns



Ohio 4-H Horse Program

www.horse.osu.edu

Legend for Patterns

READ instructions carefully, diagrams may be abbreviated

Walk or Hand Gallop or _____

Trot, Jog or Show Gait - - - - -

Sitting Trot - . - . - . - . - . -

Extended Trot or Jog — . . — . . — . . — . .

Canter or Lope or Hand Gallop _____

Back ←  or ||||

Markers ▲ or (A)

Sidepass // // // //

Judge (J)

When a pattern is finished, either line up or exit the arena as directed by the ring steward.

Hunter Hack

1. After second fence, hand gallop from 2nd marker to 3rd marker.
2. Stop and back at least 5 steps.
3. Drop your reins to signal completion.

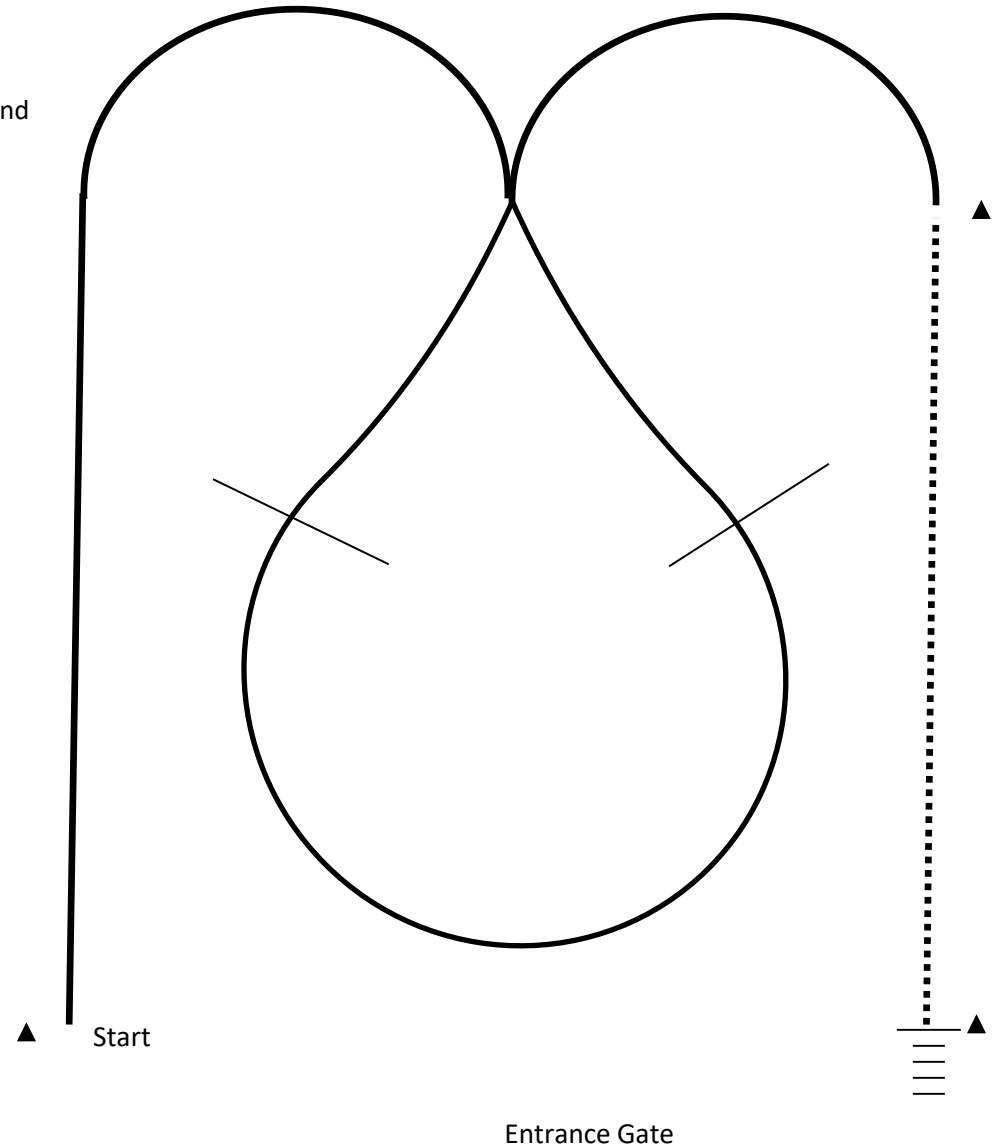

Equitation Over Fences

PAS 2020

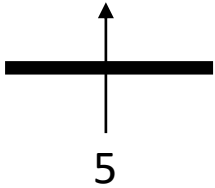

72 ft

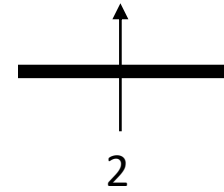
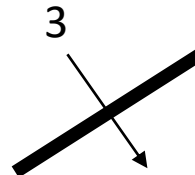
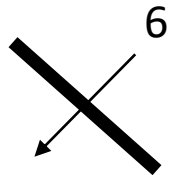

60 ft

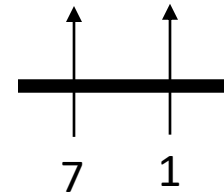
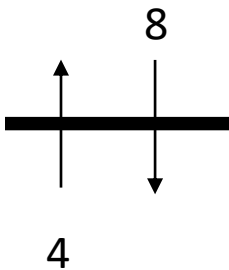

Fence Heights:

Horse and Medium/Large Pony – 2'3"

Small Pony – 2'

Entrance Gate

Hunter Over Fences

PAS 2020

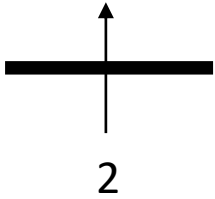

72 ft

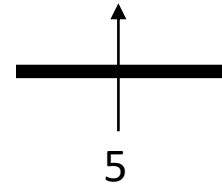
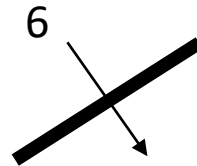
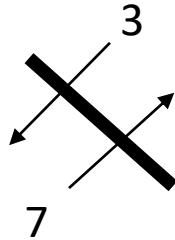

60 ft

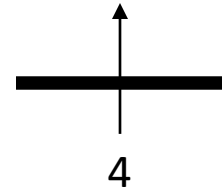
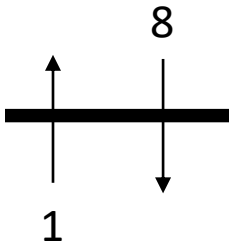

Entrance Gate

Fence Heights:
Horse and Medium/Large Pony – 2'6"
Small Pony – 2'

Junior Western Showmanship

PAS 2020

1. Trot from A to B.
2. Stop and perform a 270° turn.
3. Walk to C.
4. Stop and set up for inspection.
5. When dismissed, perform a 90° turn.
6. Trot to line-up.

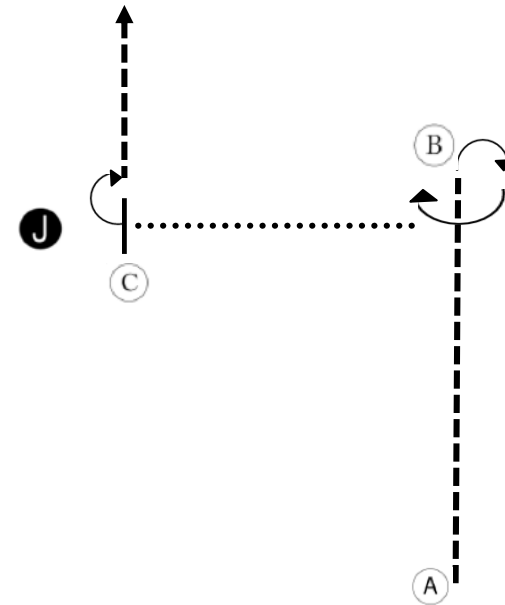

Entrance Gate

Senior Western Showmanship

PAS 2020

1. Trot from A halfway to B.
2. Break to walk and walk to B.
3. Stop and perform a 90° turn.
4. Back 4 steps and perform a 180° turn.
5. Trot to C.
6. Stop and set up for inspection.
7. When dismissed, perform a 90° turn.
8. Trot to line-up.

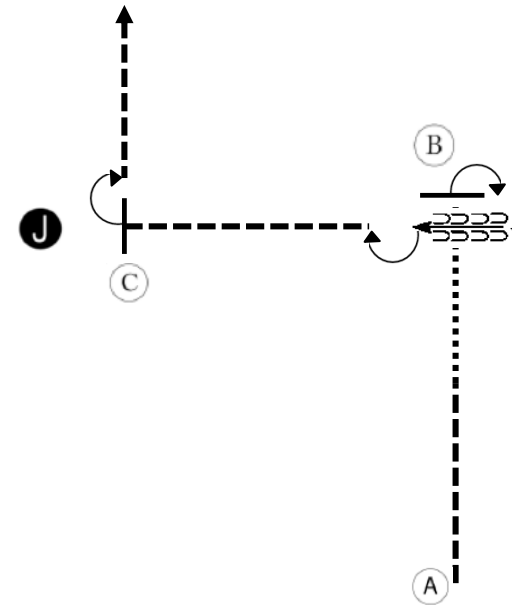

Entrance Gate

Junior Hunter Showmanship

PAS 2020

Be ready at A.

1. Trot around B and to C.
2. Break to a walk and walk around C to D.
3. Turn 90° and walk to Judge.
4. Stop and set up for inspection.
5. When dismissed, back approximately one horse length.
6. Turn 90° and trot away from the Judge.

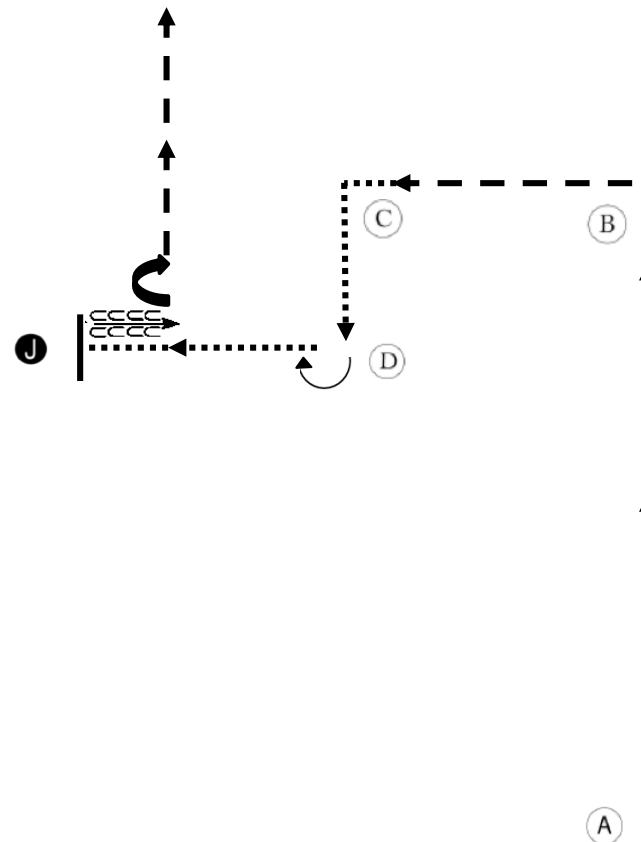

Entrance Gate

Senior Hunter Showmanship

PAS 2020

Be ready at A.

1. Trot around B and to C.
2. Break to a walk and walk around C to D.
3. Turn 450° and walk to Judge.
4. Stop and set up for inspection.
5. When dismissed, back approximately one horse length.
6. Turn 90° and trot away from the Judge.

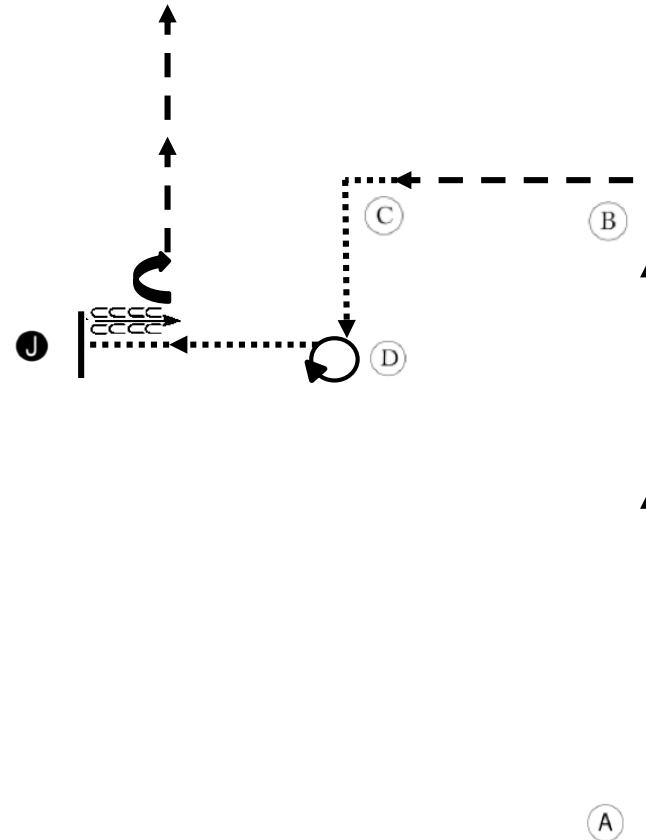

Entrance Gate

Draft Showmanship

PAS 2020

1. Enter arena at trot and line horse up on a $\frac{3}{4}$ view facing the arena fence.
2. When judge signals, back horse 5 steps off rail, turn and go to judge.
(As horse leaves line up other exhibitors will move their horses down the wall and wait for judge's signal)
3. Walk horse away from judge $\frac{1}{2}$ way down ring, trot 2nd half.
4. Make a golf club turn & continue walk $\frac{1}{2}$ way back to judge, trot 2nd half.
5. Stop & pose horse for inspection.
6. When excused, go to the end of the line and move up until returned to the original position.

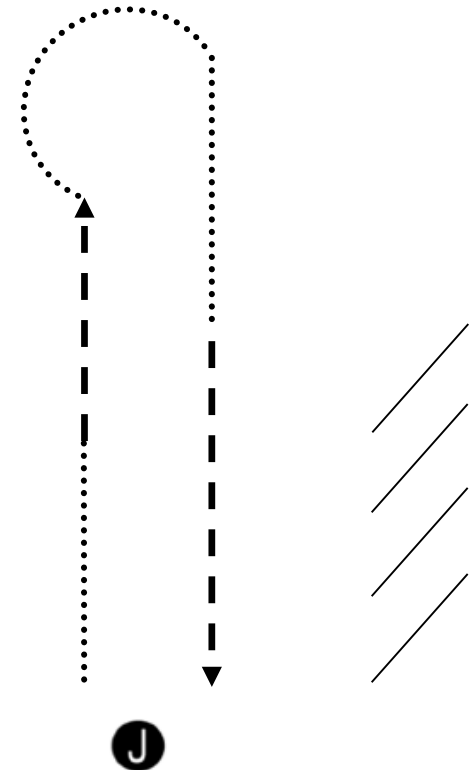

Entrance Gate

Easy-Gaited & Saddle Type Showmanship

PAS 2020

Be ready at A.

1. Trot to and around B.
2. Walk from B until past Judge.
3. Back until horse's hip is even with Judge.
4. Perform a 90° turn.
5. Trot to Judge.
6. Stop and set up for inspection.
7. When dismissed, perform a 270° turn.
8. Walk straight away from Judge.

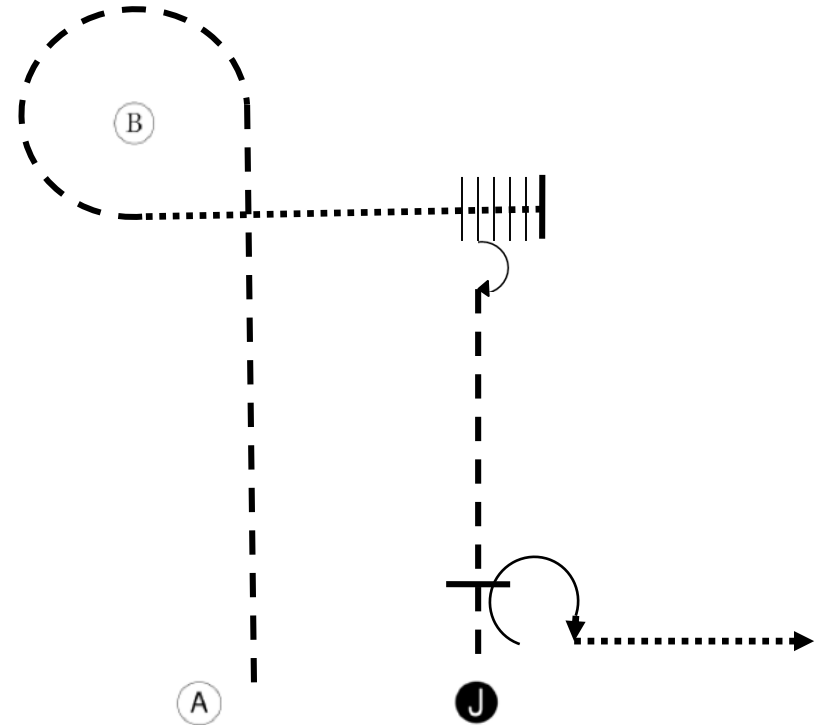

Entrance Gate

Small Equine Showmanship

PAS 2020

1. Trot from A to B.
2. Stop and perform a 270° turn.
3. Walk to C.
4. Stop and set up for inspection.
5. When dismissed, perform a 90° turn.
6. Trot to line-up.

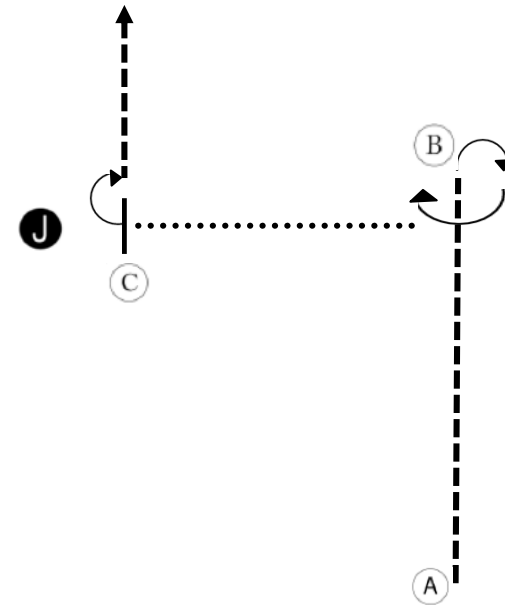

Entrance Gate

Junior Western Horsemanship

PAS 2020

Be ready before marker A.

1. Walk to A.
2. Jog to B.
3. Extended jog to C.
4. Lope left lead in circle to D.
5. Stop at D and back approximately one horse length.
6. Perform a 90° turn to the left.
7. Jog to exit.

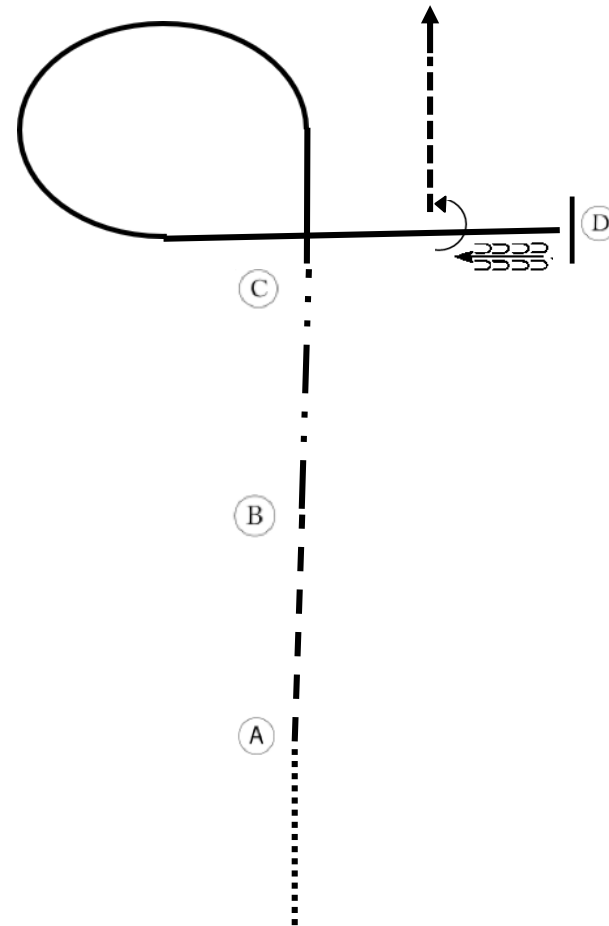

Senior Western Horsemanship

PAS 2020

Be ready before marker A.

1. Walk to A.
2. Lope on left lead to B.
3. Jog to C.
4. At C, perform a 270° turn to the right.
5. Lope on right lead to D.
6. Stop at D and back approximately one horse length.
7. Perform a 90° turn to the left.
8. Extended jog to exit.

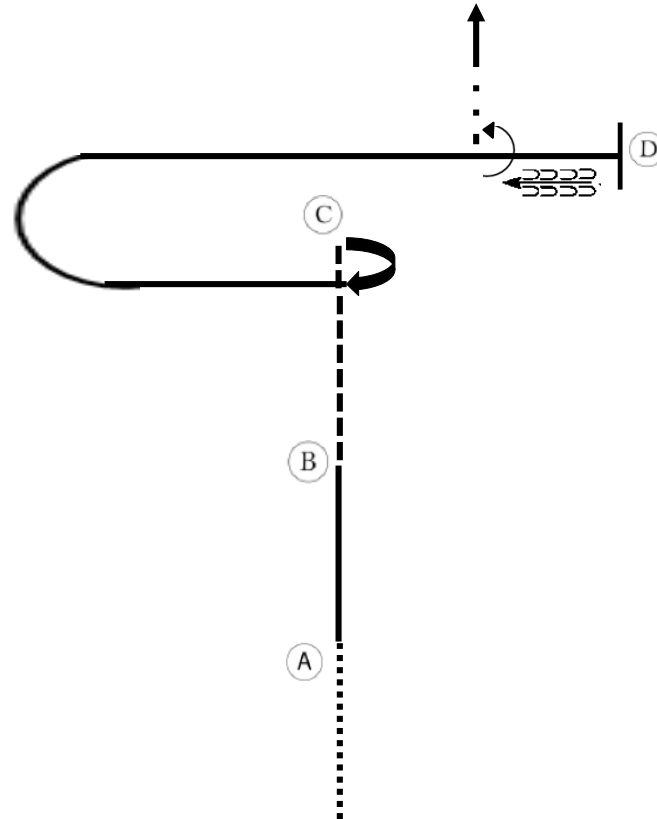

Junior Hunt Seat Equitation

PAS 2020

Be ready before A.

1. Walk to A.
2. Sitting trot from A to B.
3. Posting trot right diagonal at B. Continue circle to the right.
4. Between B and C canter left lead to D.
5. Stop at D and back one horse length.
6. Turn 90° right on forehand.
7. Posting trot left diagonal to exit.

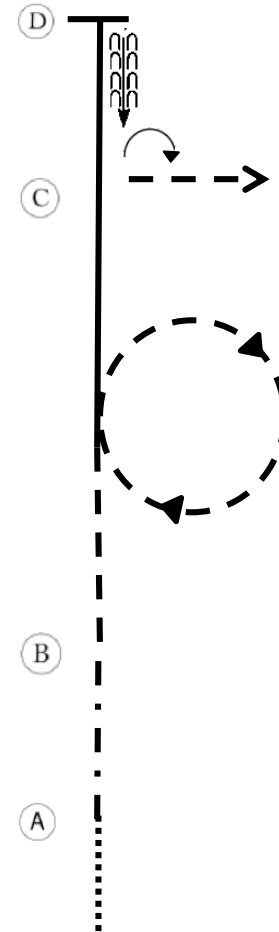

Entrance Gate

Senior Hunt Seat Equitation

PAS 2020

Be ready before A.

1. Walk to A.
2. Sitting trot from A to B.
3. Right lead canter at B. Circle to the right.
4. Simple lead change of leads between B and C.
5. Canter left lead to C.
6. Stop at C and back one horse length.
7. Posting trot on the right diagonal to D.
8. Stop at D.

When dismissed, follow the instructions of your ring steward.

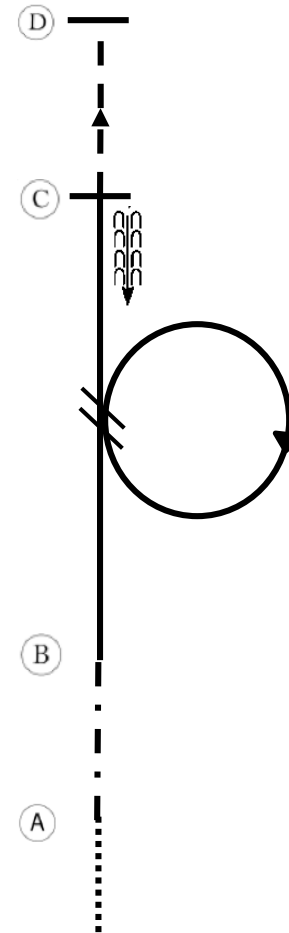

Entrance Gate

Easy Gaited Equitation

PAS 2020

1. Show Walk from A to B.
2. At B, show walk a circle to the right.
3. Show gait a circle to the left.
Continue to show gait until you reach C.
4. At C, stop, back at least 5 steps, and turn 180° on the forehand to the left.

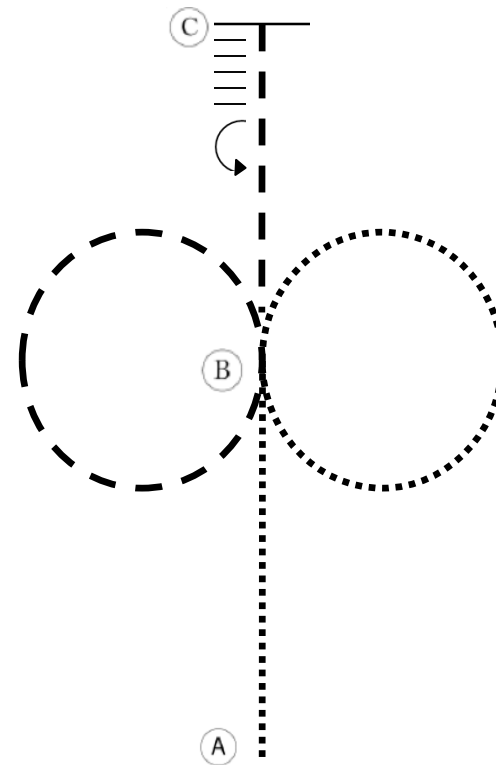

Entrance Gate

Saddle Seat Equitation

PAS 2020

Be ready at A.

1. Walk from A to B.
2. At B, posting trot on left diagonal to C.
3. At C, stop and reverse to right 180°.
4. Posting trot on the right diagonal to B.
5. At B, stop and reverse to the left 90°.
6. Canter on the right lead to D.
7. At D stop and back four steps.

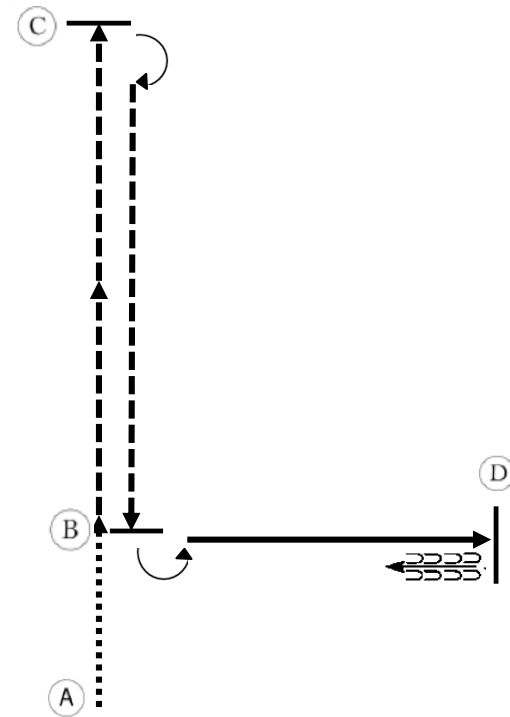

Entrance Gate

Driven Trail

PAS 2020

1. Trot a serpentine around the first 3 cones and continue to cone 4.
2. Walk a circle around cone 4
3. Continue to walk into the corner of the arena, stopping half-way through the corner.
4. Trot out of the corner and down the rope, with the rope between the wheel and the horse.
5. Walk to the final obstacle and back into the chute. You may start on either side of the cone in front of the back-in obstacle.
6. Stop and wait for the judge's dismissal.

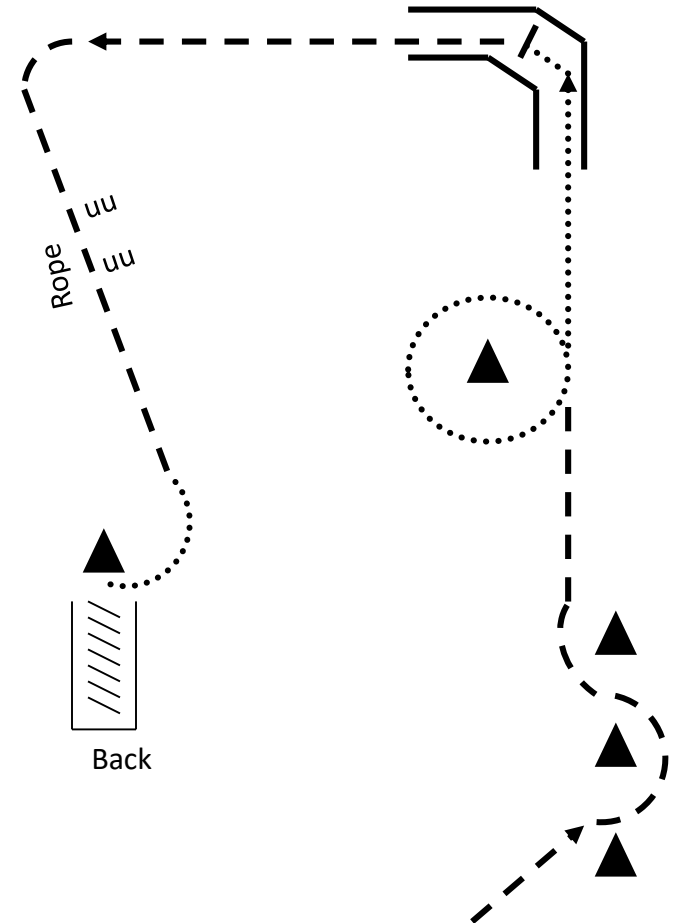

Entrance Gate

Driving Reinsmanship

PAS 2020

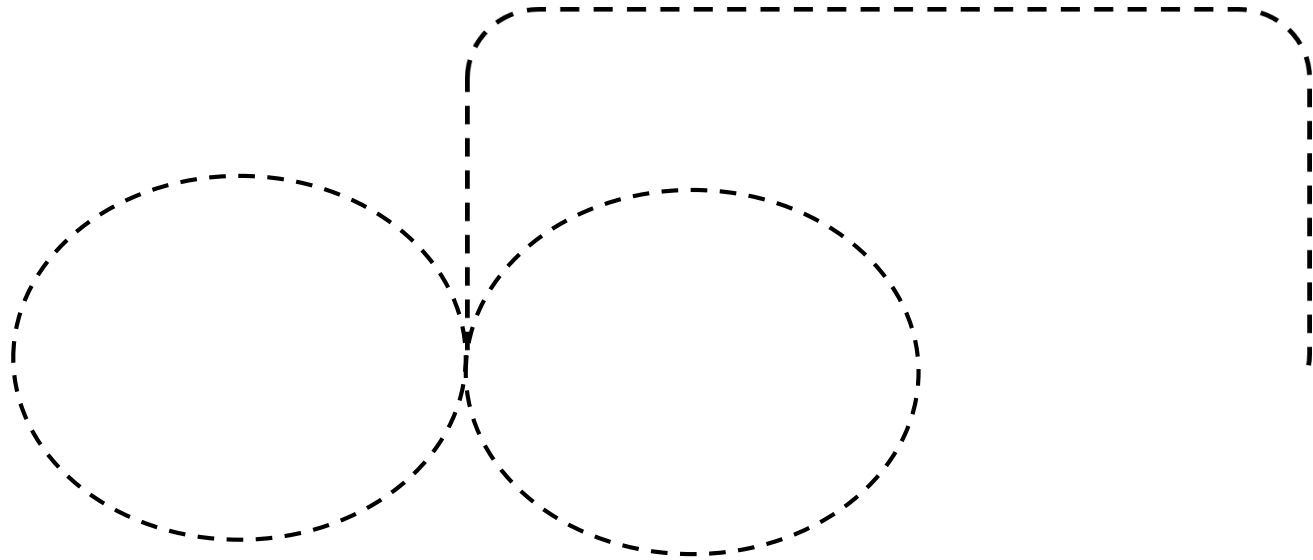

Judge

1. Begin at working trot/gait. Drive down centerline until even with judge, halt & salute.
2. Perform a figure 8 in the direction designated by the judge ahead of time (left or right) at the working trot/gait.
3. Halt, salute & exit at the walk.

Trail

PAS 2020

1. Begin at A. Walk to & work rope gate.
2. Jog over poles.
3. Side pass left to end of pole, then side pass right to center of pole.
4. Walk over bridge.
5. Jog over poles to chute.
6. Back through chute and jog out.
7. Jog serpentine.
8. Lope over poles to the box.
9. Walk into the box, turn 360° and walk out.

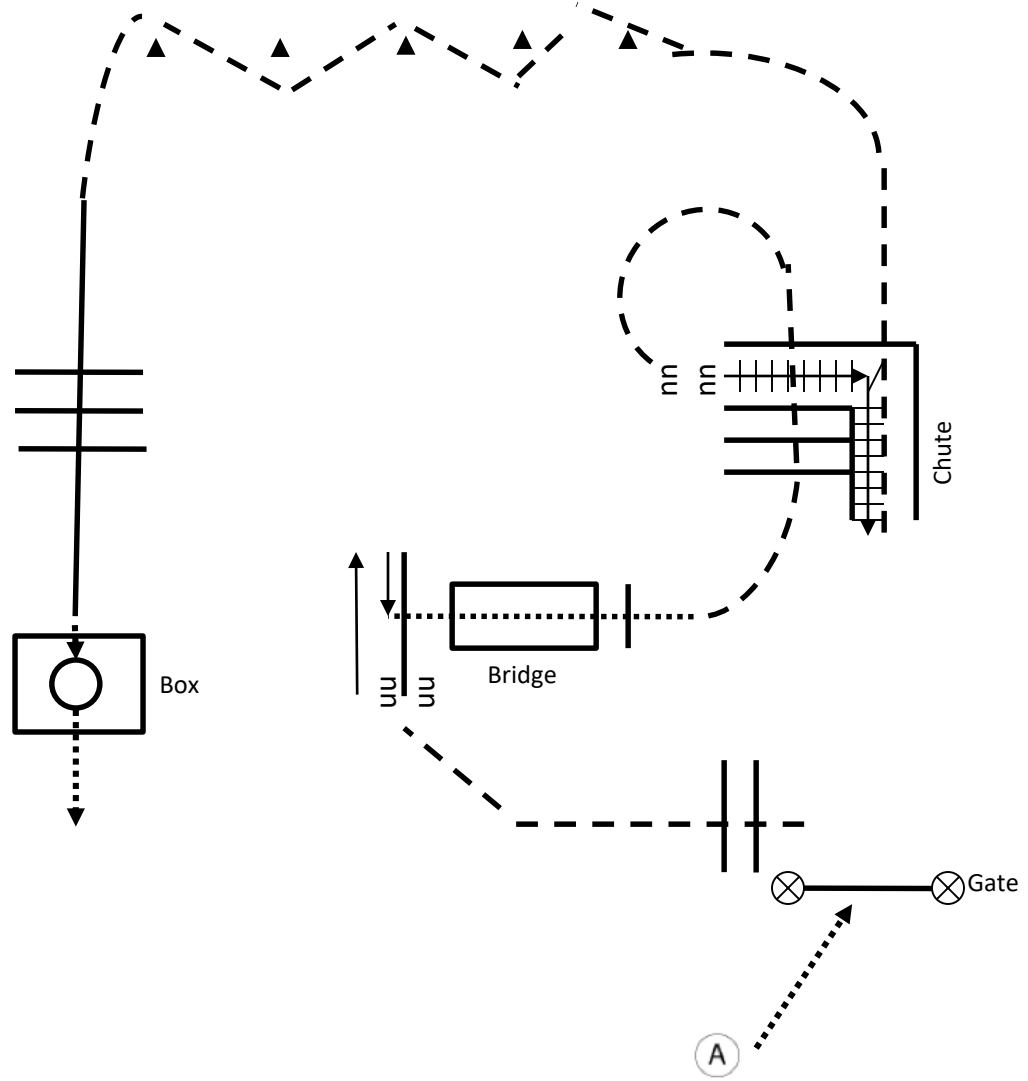

Entrance Gate

Trail in-Hand

PAS 2020

1. Begin at A at the walk.
2. Jog/Show Gait over poles.
3. Side pass left to end of pole, then side pass right to center of pole.
4. Walk over bridge.
5. Jog/Show Gait over poles to chute.
6. Back through chute.
7. Jog serpentine.
8. Jog/Show Gait over poles to the box.
9. Walk into the box, turn 360° and walk out.

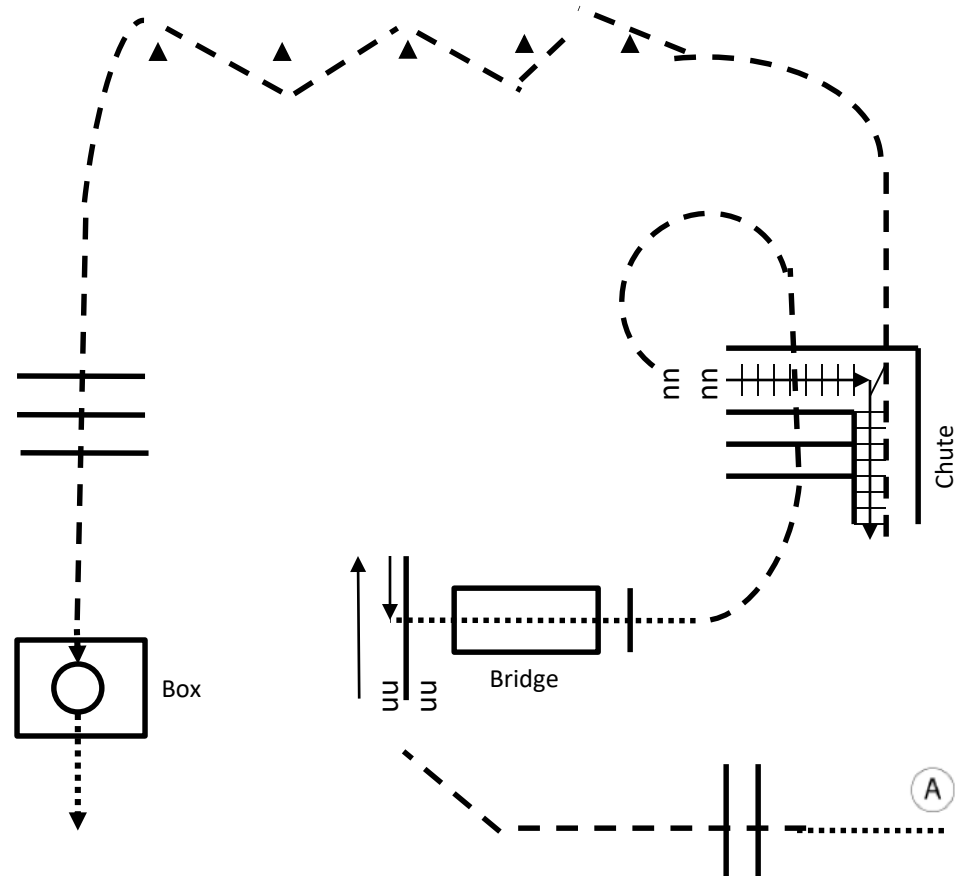

Entrance Gate

Small Equine Jumpers

PAS 2020

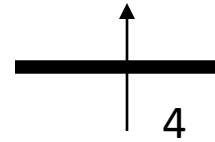
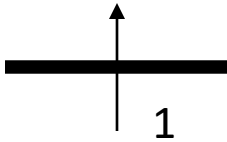
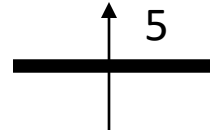
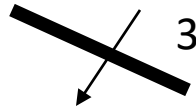
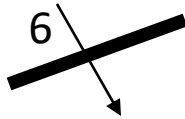
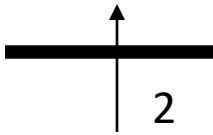

Entrance/Exit Gate

Fence Heights: 12-24"

Small Equine Hunter In-Hand

PAS 2020

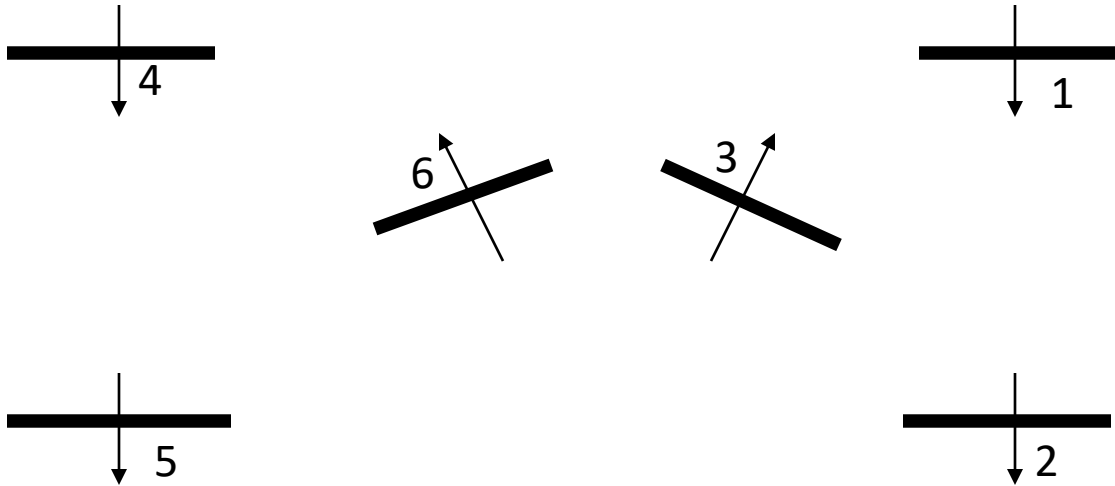

Entrance/Exit Gate

Fence Heights: 12-24"

Western Riding will use pattern A on page 59 of your Rulebook.

Reining will use Pattern C on page 56 of your Rulebook.

Ranch Riding will use Pattern B on page 48 of your Rulebook.